

DWG# 8465B

P/N	MAT'L	GAGE	WIDTH	LENGTH	QTY

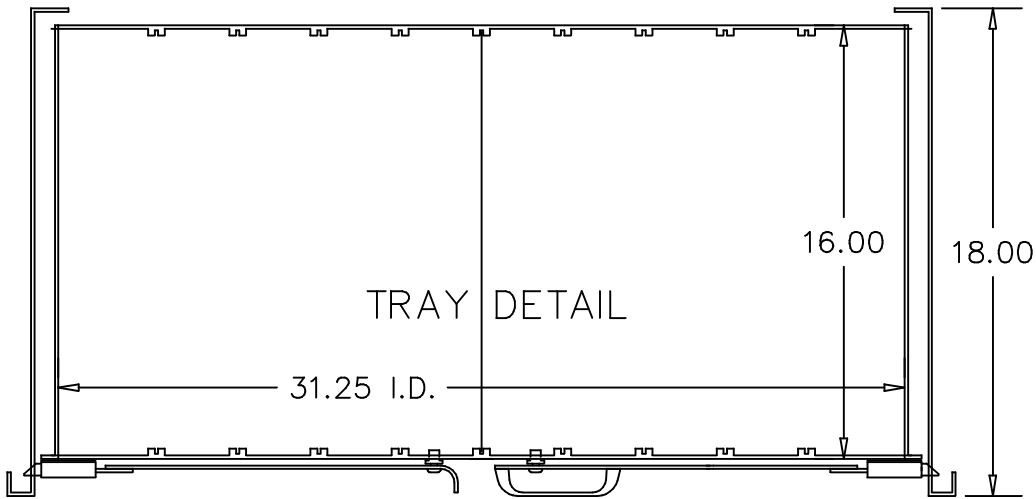

*HEAVY DUTY SERIES*

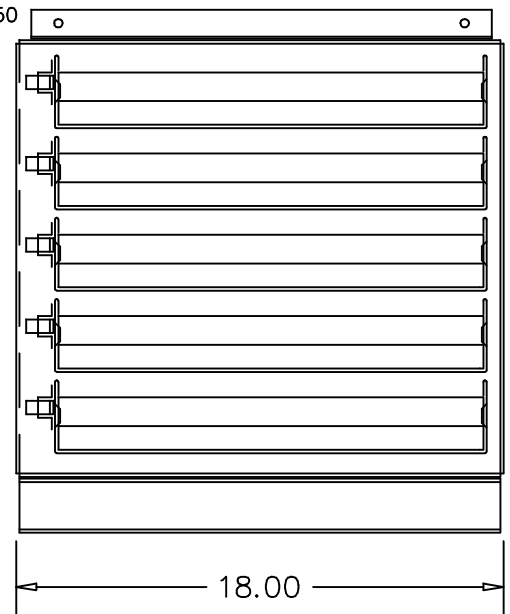
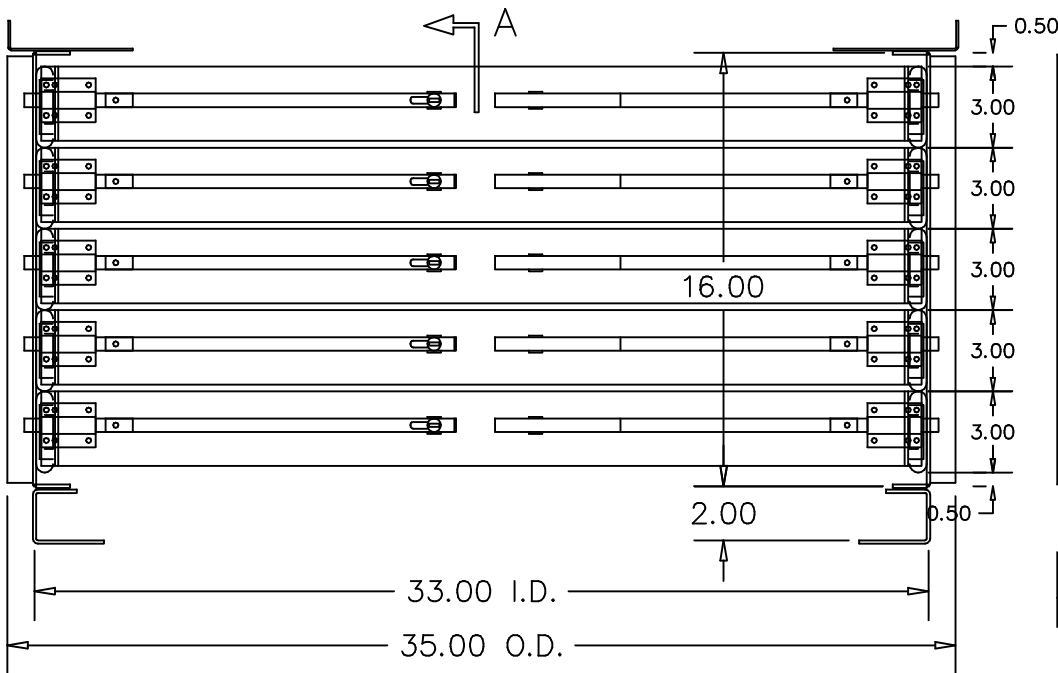

*CUSTOMER APPROVAL* PLEASE MARKUP OR SIGN AS APPROVED AND FAX BACK TO (801) 363-8119

SIGNED:	P.O. #	DATE:
---------	--------	-------